

DACIA SPRING

100% ELECTRIC



READY FOR LIFE

Bold, assertive and connected, all new Dacia Spring 100% electric welcomes you with a modern and robust design and its spacious and clever interior. Designed for real life, the ultimate companion for city living.



**140 MILES
DRIVING RANGE⁽¹⁾**

**BEST IN CLASS BOOT
VOLUME: 308 LITRES⁽²⁾**

**MEDIA NAV LIVE
MULTIMEDIA SYSTEM⁽⁴⁾**

**YOUCLIP
ATTACHMENT SYSTEM**

**30 kW DC RAPID
CHARGER COMBO⁽³⁾**

**VEHICLE TO LOAD
(V2L)⁽⁴⁾**

(1) In WLTP combined cycle. (2) 288 dm³ (VDA standard). (3) Optional on 65 hp versions. (4) Vehicle to load is only available on the extreme version.

INTERACTIVE MENU

01. DESIGN

02. DRIVING PLEASURE

03. CONNECTIVITY

04. INTERIOR SPACE

**05. DRIVER ASSISTANCE
SYSTEMS**

06. FOR PROFESSIONALS

**07. EQUIPMENT AND
ACCESSORIES**

ALL-NEW DACIA

With a striking look and packed with interior equipment. Dacia's bold electric vehicle is causing a stir. Strong and stylish, its compact SUV look stands out from the rest and asserts itself from every angle with its high ground clearance, reinforced wing and grille protections, and 15" wheels.



The emblematic Y-shaped lighting signature energises the front-end, which is just as ready to devour the city as it is to explore the countryside.



Urban-inspired front bumper



LED lights with Y signature



Side protection

INTERIOR EXPERIENCE

With everything close to hand the interior focuses on ergonomics, aesthetics and perceived quality. The coloured elements and backlit controls add to the personality of the interior.



The functional design of the dashboard is structured around the 10.1" multimedia display and the 7" digital on-board computer on which all vehicle information is shown. The e-shifter gear selector, height-adjustable steering wheel and range of upholstery creates a distinctive style.



e-shifter gear lever

ELECTRIC LIFE

Silent and responsive driving, electric mobility is within everyone's reach with all new Dacia Spring. With its dual engine offer of 45 HP or 65 HP choose the one that suits you best.



In terms of performance, you can cover 140 miles in the WLTP combined cycle or 190 miles in the WLTP urban cycle without needing to recharge, go from 20% to 80% range in 45 minutes with the rapid charger*. The new regenerative braking mode, "B Mode", recovers energy when you take your foot off the accelerator, and also when you apply the brakes to make driving easier. You can also take advantage of *power to object*, two-way charge V2L (Vehicle to load) technology that lets you connect your everyday electrical appliances to your all new Spring.

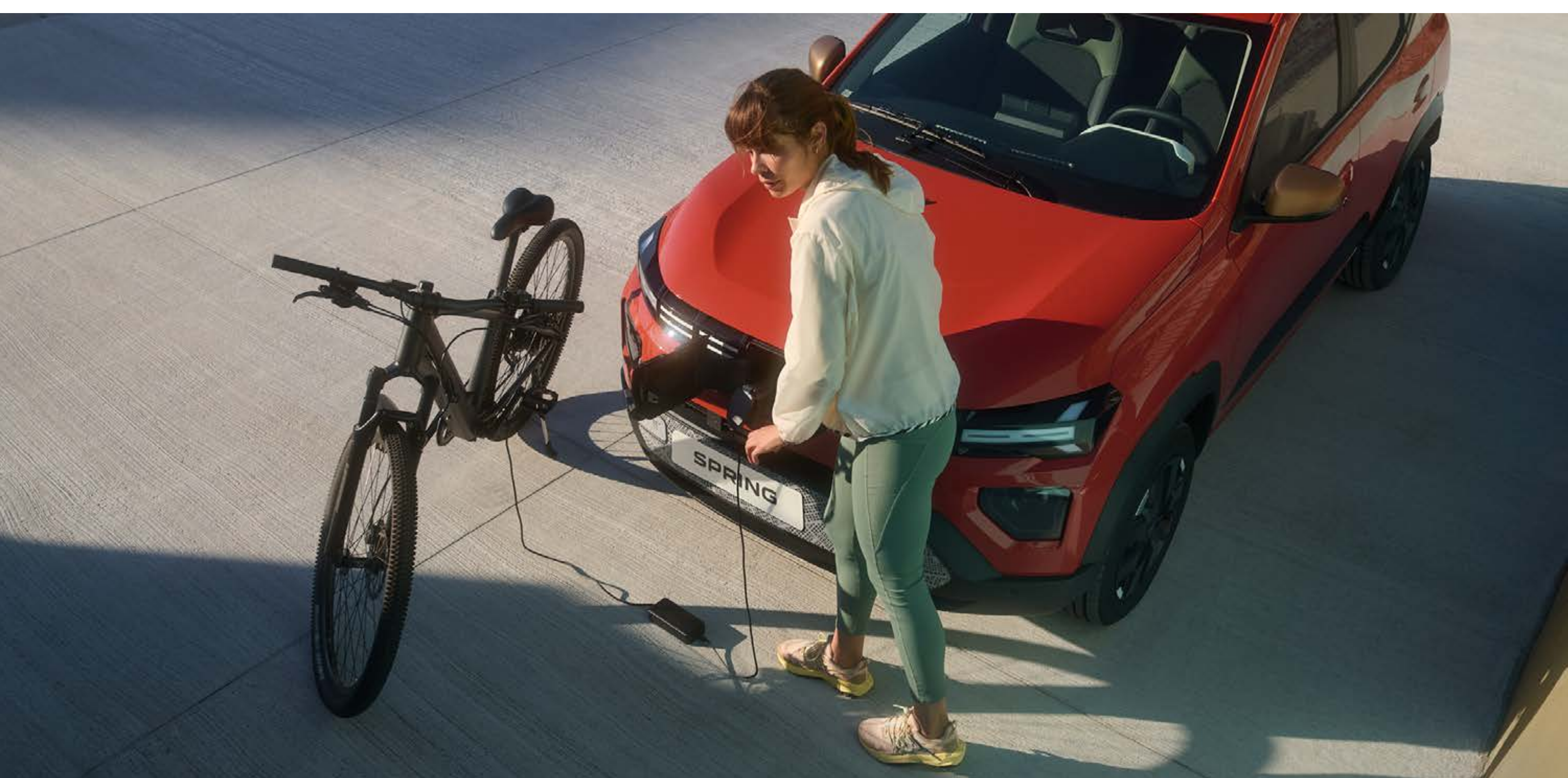

Power to object, two-way charge V2L (Vehicle to load)*

*Standard with Electric 65 motor

[CONFIGURE AND ORDER](#)

[MENU](#) ^

EVEN MORE CONNECTED

Your journeys go without a hitch thanks to the Media Nav Live multimedia system, which simplifies your daily life. On its large 10.1" touchscreen, get navigation support with always up-to-date mapping and real-time traffic (included for 8 years). And to make your journeys easier, enjoying wireless smartphone mirroring (Android Auto™ or Apple CarPlay™). Finally, get comprehensive driving and consumption information on the new 7" digital on-board computer.



Also enjoy convenient connected services so you can schedule your charging or preheat your car remotely* – all via your smartphone.



Always up-to-date navigation with real-time traffic

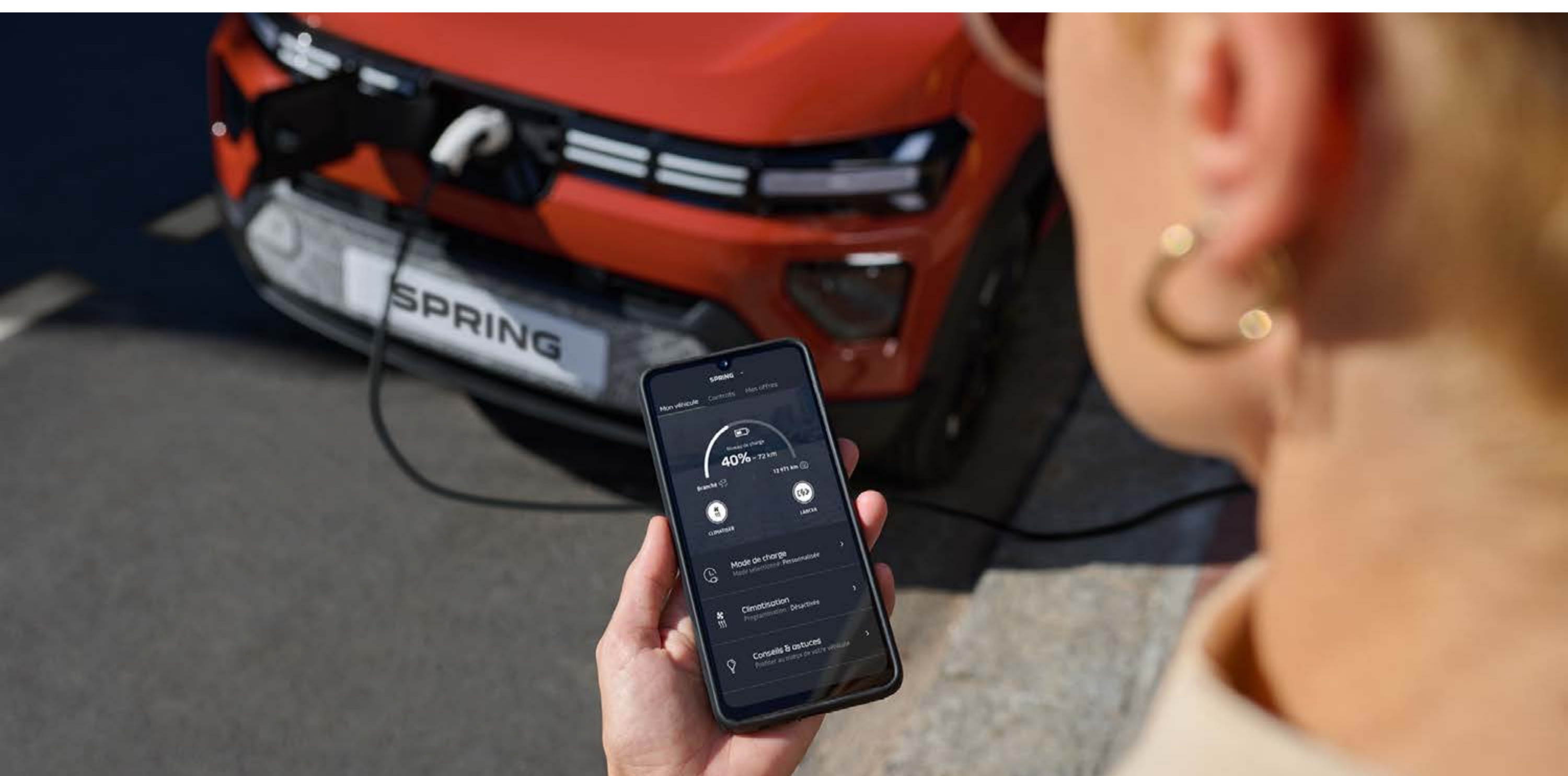

MY Dacia application

* Available depending on the country on versions with the central 10.1" screen. Android Auto™ is a trademark of Google Inc. Apple CarPlay™ is a trademark of Apple Inc.

[CONFIGURE AND ORDER](#)

[MENU](#) ^

COMPACT AND SPACIOUS

All New Dacia Spring defies the laws which govern interior space with four comfortable seats. It's carefully designed interior offers numerous storage areas to accommodate your personal items, with up to 32.7 litres of easy-to-reach capacity.

And for even more possibilities, a wide range of accessories such as a exclusive cup holders and a clever frunk under the bonnet, which provides an additional 35 litres of useful volume.



With the best storage capacity in the category, its record 308-litre boot and its YouClip multi-use attachment system the all new Dacia Spring has the ability to make your everyday life easier.



YouClip multi-use attachment system



Additional 35-litre frunk available as a accessory

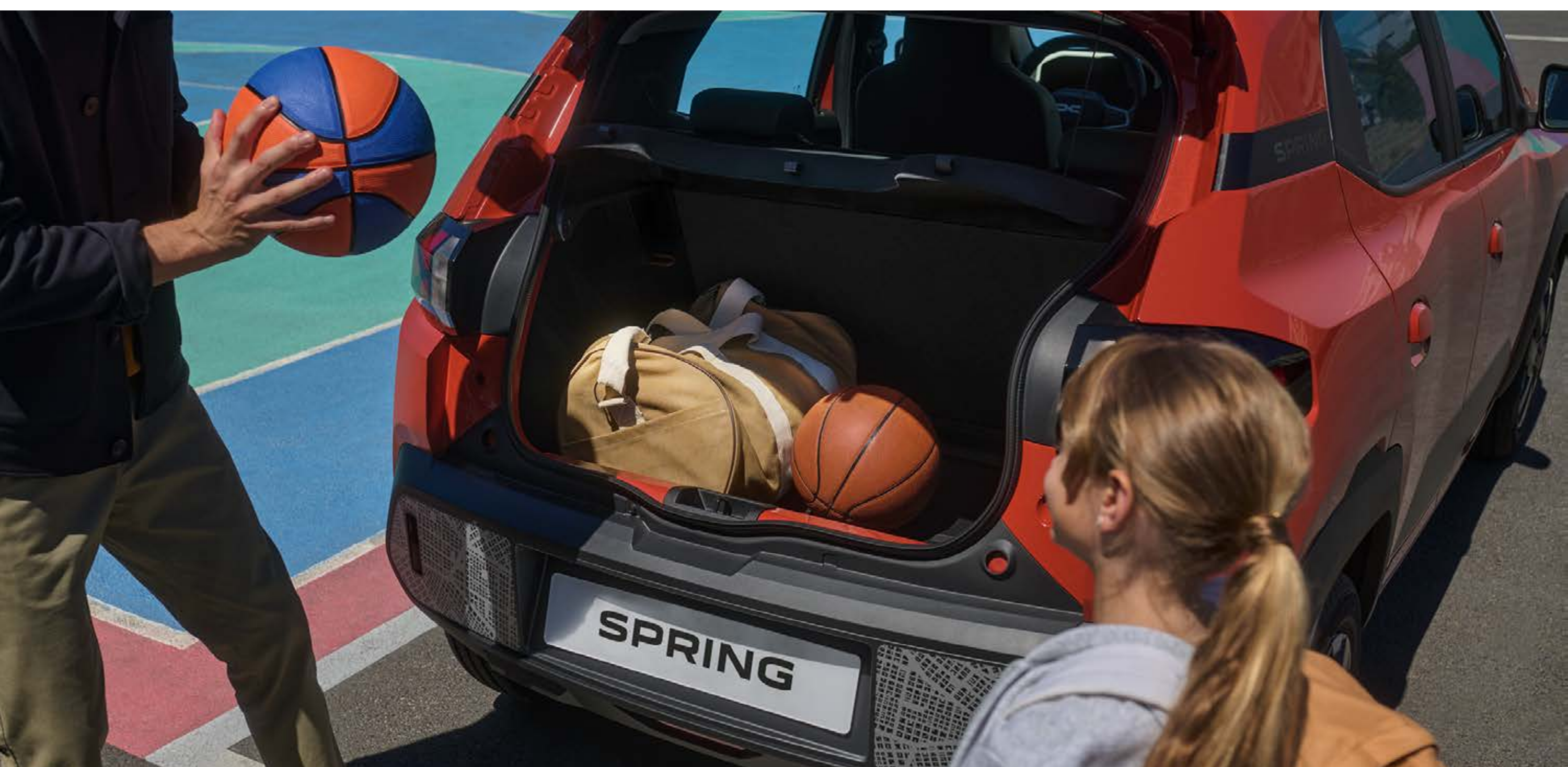

Best in class boot capacity of 308 litres

[CONFIGURE AND ORDER](#)

[MENU](#) ^

DRIVE IN COMPLETE SAFETY

New assistance systems are featured in the All New Dacia Spring to make driving even easier while constantly improve your safety. With the new My Safety button, manage some of these assistance features at any time. With Dacia, drive with peace of mind.

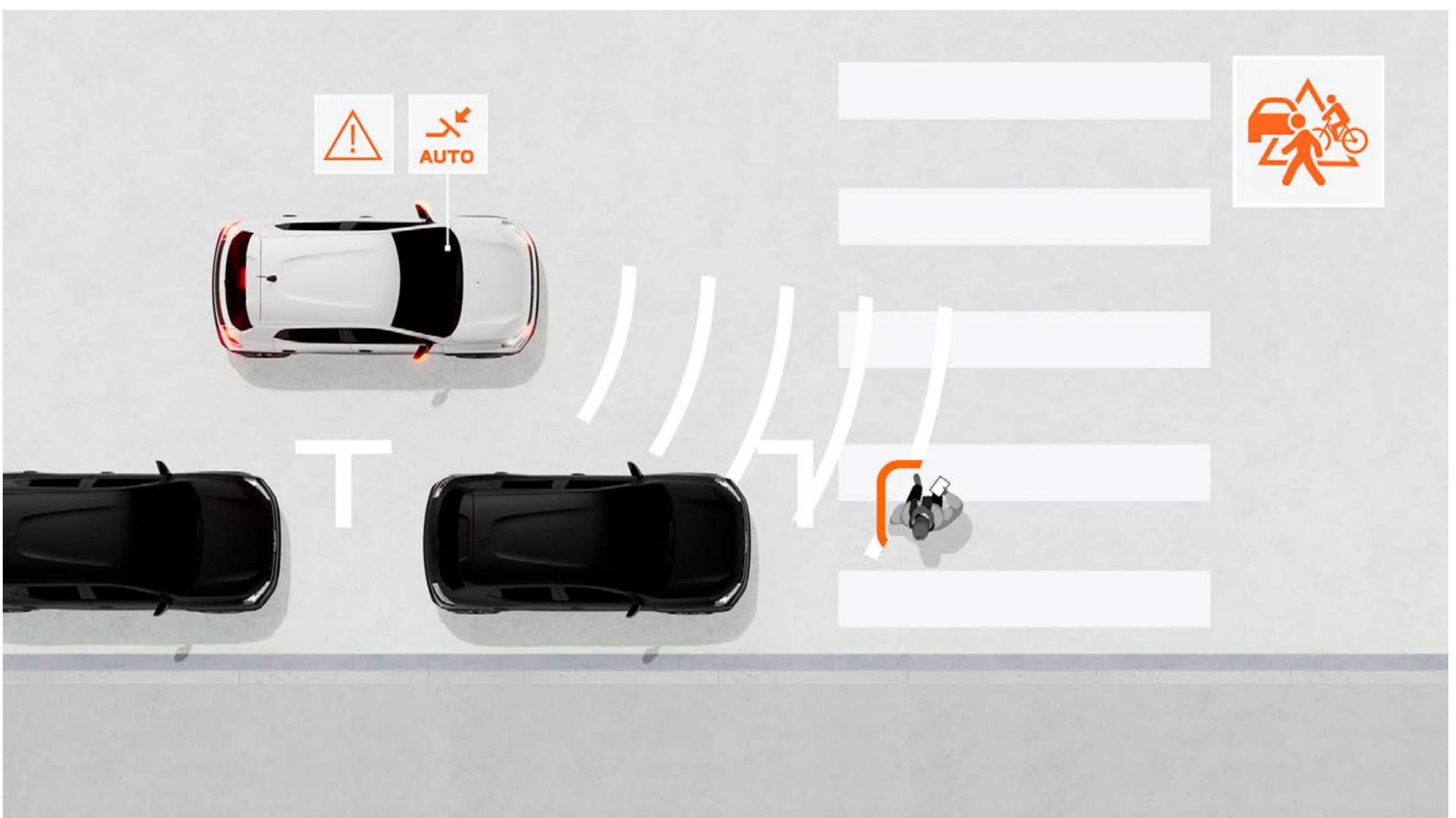

AUTOMATIC EMERGENCY BRAKING WITH PEDESTRIAN/CYCLIST DETECTION

This system prevents the risk of frontal collisions involving other vehicles, pedestrians or cyclists straight ahead and at junctions. It alerts the driver and can automatically brake the vehicle if necessary.

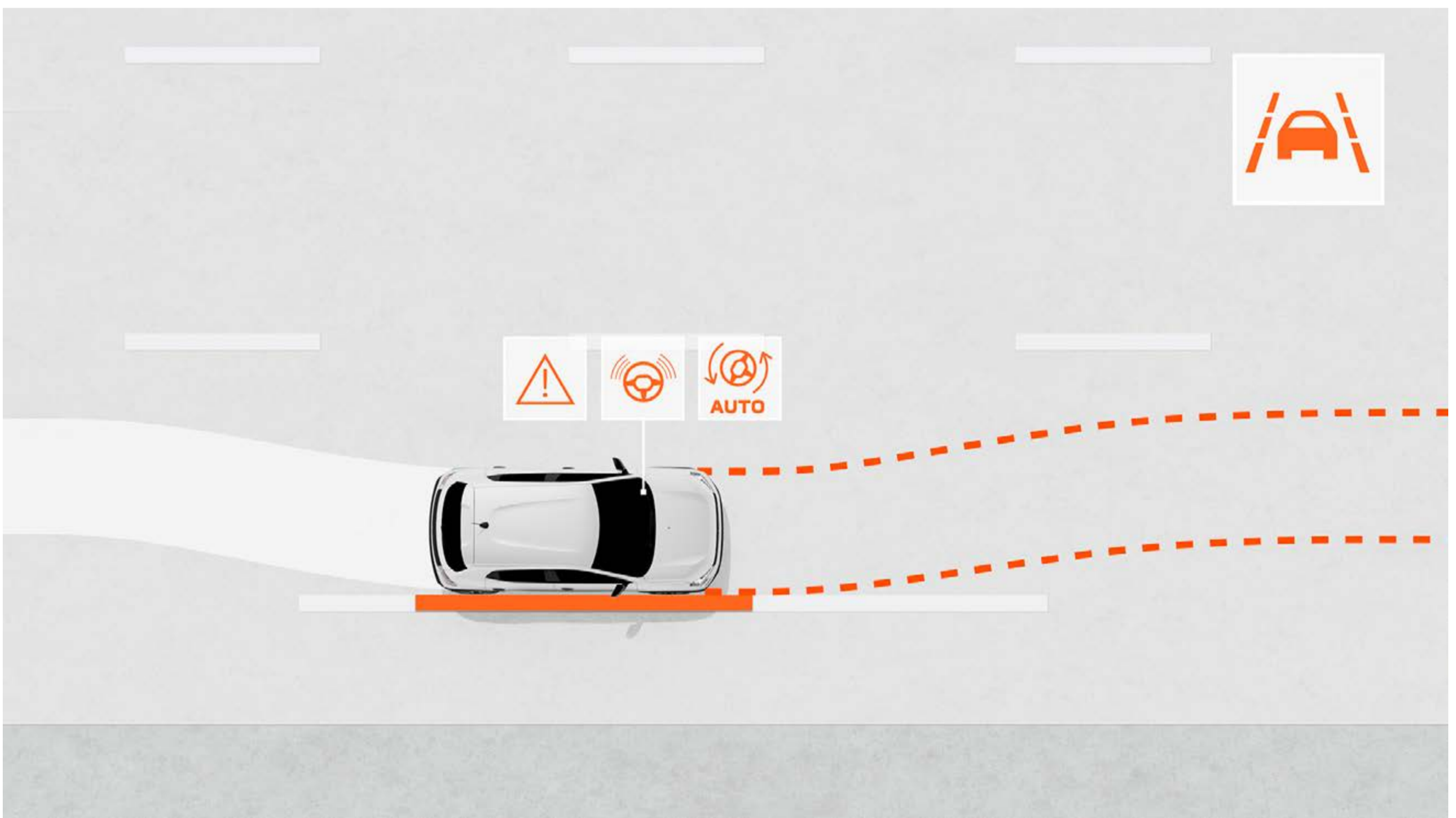

LANE KEEPING ASSIST

This assistance system monitors the vehicle's path in its lane and corrects it if necessary by automatically steering it.



DRIVER FATIGUE DETECTION SYSTEM

This assistance system warns the driver if fatigue is detected and prompts them to take a break.

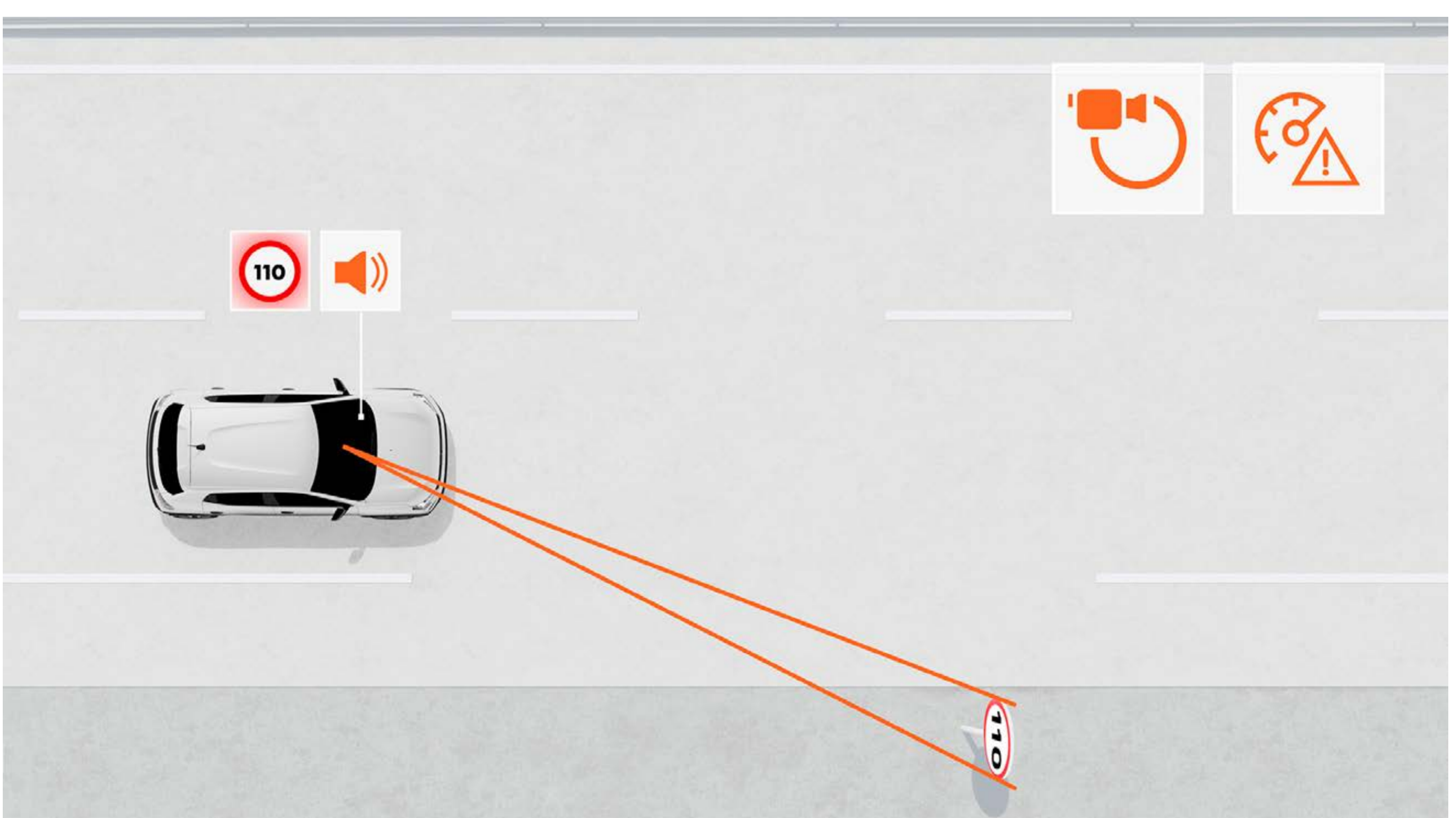

TRAFFIC SIGN RECOGNITION WITH SPEEDING ALERT

This system provides a real-time indication of the maximum speed on the road and warns the driver if they exceed the speed limit with visual and audible alerts (which can be disabled).

SPRING CARGO

Dacia Spring Cargo 100% electric is the utility version for professionals who want simplicity, reliability and robustness in every respect.

Its practicality stands out: 2 seats in the front, the entire rear is for business activities and for transporting goods. Emphasis on efficiency: sill protectors and reinforced boot mat, 4 lashing rings, and mesh separation partition. Its standard equipment is also generous: Media Nav Live multimedia system with 10.1" touchscreen, Bluetooth[®], 2 USB sockets. On the outside, black grain-finish handles and door mirrors for optimum durability plus vehicle to load allowing you to power external appliances straight from the Spring.



**140 MILES
OF DRIVING RANGE⁽¹⁾**

**370 KG OF
PAYLOAD**

**1085 LITRES
OF LOAD VOLUME**

**ROBUST MATERIALS
FOR TRANSPORTING
GOODS**

(1) In WLTP combined cycle.

[CONFIGURE AND ORDER](#)

[MENU](#) ^

DISCOVER THE EQUIPMENT

COLOUR PALETTE



TRIMS



ACCESSORIES

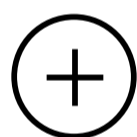

ENGINES

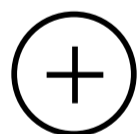

EQUIPMENT AND OPTIONS

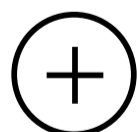

DIMENSIONS



07. COLOUR PALETTE

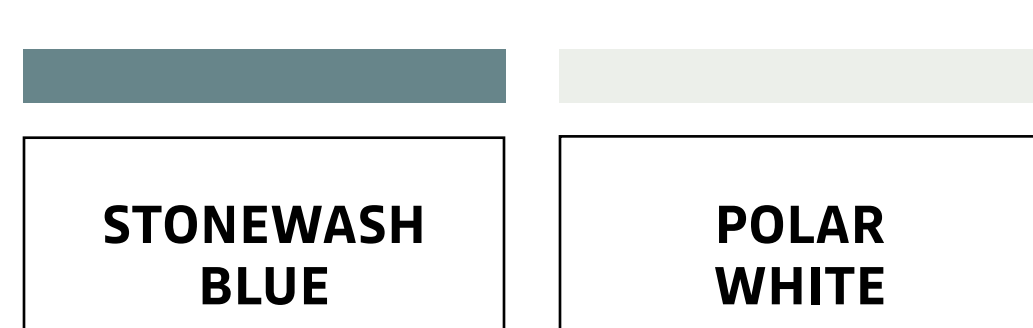
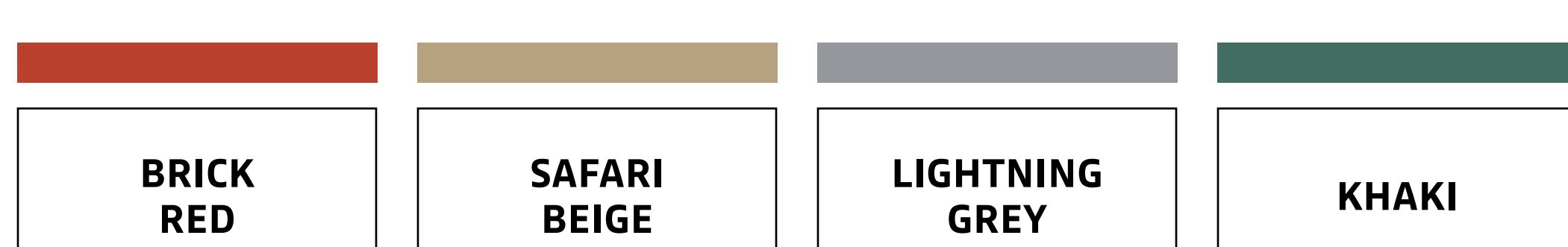

BRICK RED⁽¹⁾



SAFARI BEIGE⁽¹⁾



LIGHTNING GREY⁽²⁾



KHAKI⁽¹⁾



STONEWASH BLUE⁽¹⁾



POLAR WHITE⁽¹⁾⁽³⁾

(1) Solid paint. (2) Metallic paint. (3) Only colour available as standard on Spring Cargo, no other colours available. Non-binding photos.

07. INTERIOR TRIMS

EXPRESSION



14" steel wheels with "Cians" styler (Standard on Electric 45 version)
15" steel wheels with "Resia" styler (Standard on Electric 65 version)

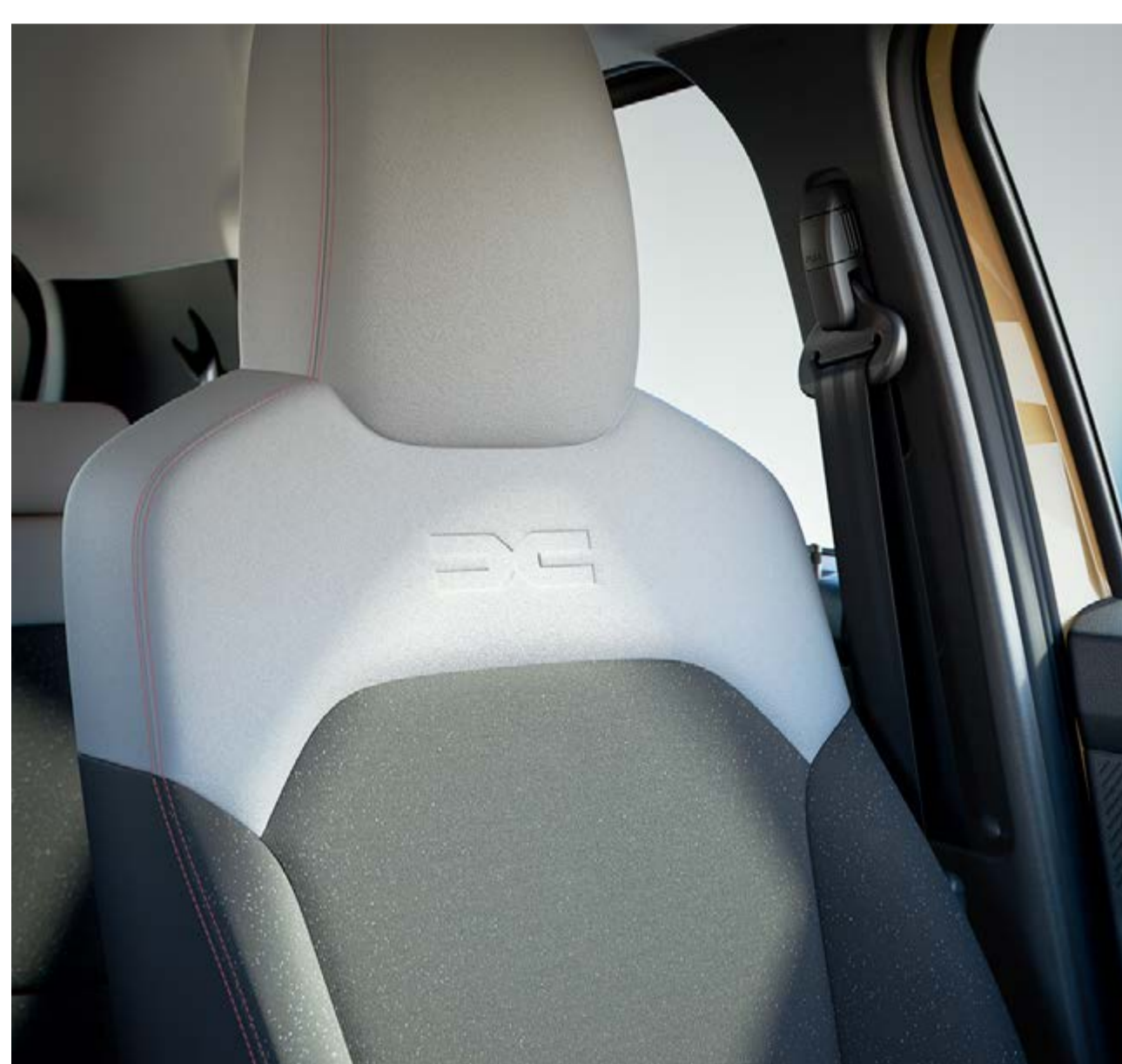

MAIN EQUIPMENT

EXTERIOR DESIGN

- Side decals
- LED daytime running lights
- Body colour exterior door handles
- 14" Cians hubcap for the 45 hp version
- 15" Resia hubcap for the 65 hp version
- Textured black door mirrors with integrated turn indicators
- Regenerative braking

INTERIOR DESIGN

- Two-tone fabric upholstery with Dacia logo embossing
- Steel grey interior door handles
- Electric power steering
- Soft feel steering wheel and steering wheel mounted controls
- Carpet mats
- Brick red dashboard decopart

CHARGING

- 7 kW AC charger
- Mode 3 type 2 charging cable (for domestic wall box use or public charging station)

COMFORT

- Manual air-conditioning with air recirculation
- Folding rear bench
- Rear parking sensors
- Rear lights with Y-shaped Dacia Brand light
- 3 YouClip fixation points

MULTIMEDIA

- Customisable 7" digital display (battery and range information, and more)
- 12V socket
- Media Control Smartphone interface incorporating DAB radio with satellite controls
- Bluetooth® & USB
- 2 front speakers

SAFETY

- AEBS/ESP/EBD/AFU/LKA/LDWS/TSR-OSP/DDAW/RPA*
- Automatic door-locking
- 6 airbags: driver and passenger front/thorax side/head curtain
- Speed limiter/ cruise control
- Automatic headlighting
- Emergency call (eCall)
- Intelligent Speed Assist: uninterrupted information about legal maximum speed limit

OPTIONS

- Metallic / special paint

* Depending on country

EXTREME



15" Danube Steel Wheels



MAIN EQUIPMENT EXTREME = EXPRESSION+

EXTERIOR DESIGN

- Copper Brown Pack: door mirrors, 15" Danube hubcap emblem and rear Dacia marking
- Side quarter panel stickers with Spring wording
- Decorative stickers on front and rear bumpers

INTERIOR DESIGN

- Mixed plastic-coated textile/fabric upholstery with Dacia embossing
- Front rubber mats and door sills with topographic patterns
- Copper accents on central and side air vents

COMFORT

- Vehicle to Load (V2L) socket (bidirectional load)
- DC 30kW rapid charger combo
- Front & rear parking sensors
- Rear-view camera
- Electrically adjustable door mirrors
- Electric rear windows
- 3 YouClip fixation points

MULTIMEDIA

- Media Nav Live multimedia system with 10.1" touchscreen: connected navigation* cabled and wireless, and Bluetooth®
- 2 backlit USB sockets

CONNECTIVITY*

- On-board and remote charging programming with the MY Dacia application, which also allows you to:
 - locate your vehicle
 - know your charge status
 - schedule charging
 - switch on the air-conditioning or pre-heating (previously set in the vehicle) remotely

* depending on countries

[CONFIGURE AND ORDER](#)

[MENU](#) ^

CARGO



MAIN EQUIPMENT

EXTERIOR DESIGN

- Automatic activation of LED daytime running lights
- Rear lights with Y-shaped Dacia brand light
- Textured black door mirrors with integrated turn indicators
- Black grain-effect exterior door handles
- 14" Lea hubcap

INTERIOR DESIGN

- Denim fabric upholstery
- Black interior door handles

ACTIVE AND PASSIVE SAFETY

- My Safety button to manage driver assistance systems
- Anti-locking braking system (ABS) + Emergency Brake Assist (EBA) with emergency stop signal
- Automatic emergency braking with pedestrian/cyclist detection
- Electronic Stability Control (ESC) with Hill Start Assist (HSA)
- Emergency call (E-call)
- Event (accident) data recorder
- Vehicle pre-disposition for alcohol interlock immobiliser
- Traffic sign recognition and speeding alert
- Lane change warning
- Lane keeping assist
- Driver fatigue detection system
- Front / rear «Rescue Code®» QR code
- Driver's front airbag
- Passenger's front airbag (can be deactivated)
- Side airbags, shoulders & curtains, head
- Front side seat belts with pretensioner and load limiter
- Tyre pressure detection
- Speed limiter / cruise control
- Automatic headlighting

COMFORT

- Front and rear parking sensors
- Rear-view camera
- Regenerative braking
- Remote central locking
- Power assisted steering
- Manually adjustable door mirrors
- Electric front windows
- Heated rear screen / rear screen wiper
- 3 YouClip fixation points

MULTIMEDIA

- Customisable 7" digital display (battery and range information, and more)
- Media Nav Live multimedia system with 10.1" touchscreen: connected navigation* cabled and wireless, and Bluetooth®
- 12 V socket and 2 backlit USB sockets
- DAB radio with satellite audio
- 2 front speakers

CARGO SPECIAL FEATURES

- 2 front seats
- Mesh partition
- Door sill and boot sill protectors
- Boot mat
- 4 lashing rings in the loading area
- Vehicle speed limited to 70 mph
- 14" wheels with Lea wheel trims
- Colour available: Polar white
- Opaque rear side windows

CHARGING

- 7 kW AC charger
- Combo DC 30 kW fast charger (65 hp version)
- Mode 2 home charging cable (10 A) and type 2 mode 3 cable*
- Power to object, two-way charge V2L (Vehicle to load)

* Depending on the country.

[CONFIGURE AND ORDER](#)

[MENU](#) ^

07. ACCESSORIES

STORAGE PACK

£289 inc. fitting



Compartmentalised boot storage box



Frunk

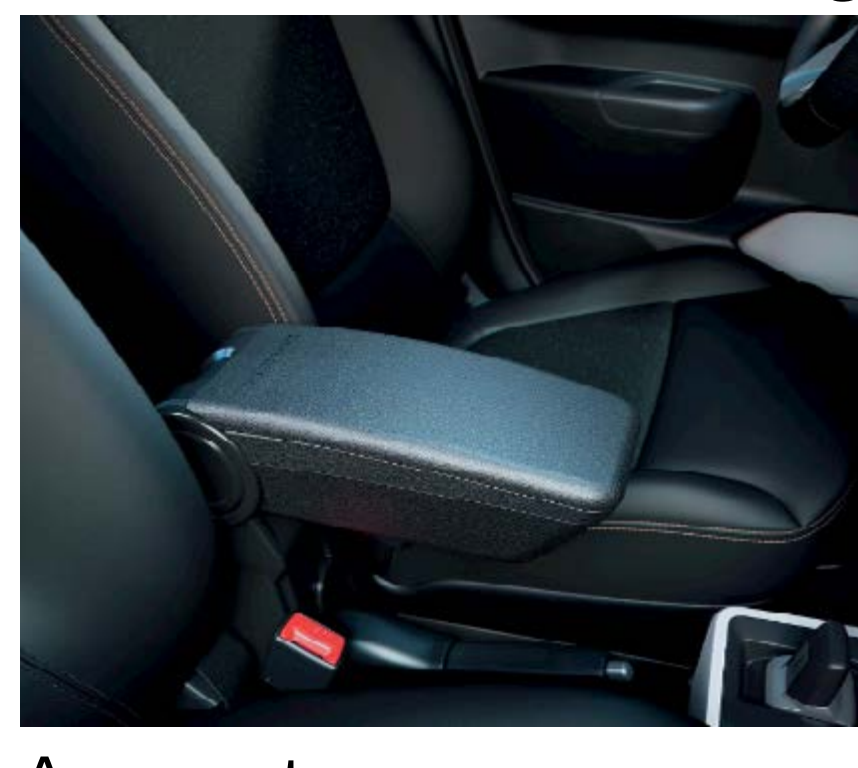

Arm rest

STYLE PACK

£242 inc. fitting



Dacia link cupholder



Decorative roof bars (Not load bearing)



Front door sills

YOU CLIP ON THE GO



YouClip - 3 in 1 (cup holder + lamp + hook) - £40



YouClip - smartphone holder - £20



YouClip - wireless smartphone charger - £41



YouClip - hook - £10



YouClip - multifunction cup holder - £15



YouClip - lamp - £21



YouClip - bag - £35

PROTECTION PACK

£427 inc. fitting



Mudguards



Front door sills



Reversible luggage compartment tray + Boot sill

DASH CAM PACK

£344 inc. fitting



Front & rear cam hard wire pack



EV PACK

£319



Domestic charging cable



Double floor for cable storage

RUBBER MAT FOR REAR SEATS

£40



Rear rubber mats

COOL BOX

£130



PREMIUM DELIVERY PACK



PREMIUM DELIVERY PACK

£100

Premium textile mats

Safety kit

Key card wallet

PREMIUM DELIVERY PACK+

£165

Premium textile mats

Safety kit

Key card wallet

Reversible luggage compartment tray

07. ENGINES

	Electric 45	Electric 65	Cargo 65
ENGINE			
Electric engine technology	Permanent magnet synchronous motor		
Fiscal rating (hp)	2		
Max. power kW EEC at engine speed of (rpm)	33 at 2,521-8,200	48 at 4,057-6,000	48 at 4,057-6,000
Max torque Nm EEC (m.kg) at engine speed of (rpm)	125 at 0-2,521	113 at 500-4,057	113 at 500-4,057
GEARBOX			
Gearbox type	Gearbox with a single gear ratio speed reducer		
BATTERY			
Usable capacity (kWh)	26.8		
Technology	Lithium-ion		
PERFORMANCE			
Maximum speed (mph)	78		
0-62 mph (s)	19.1	13.7	13.7
0-31 mph (s)	6	3.9	3.9
CERTIFIED DRIVING RANGE WLTP*			
Certified driving range in City WLTP (miles)	190		
Certified driving range in Combined WLTP (miles)	140		
CERTIFIED ELECTRICITY CONSUMPTION WLTP*			
Certified consumption in combined cycle (Wh/km)	141	135	135
Certified consumption in city cycle (Wh/km)	115	115	115
CHARGING TIME			
On-board charger	Single-phase from 2 kW to 7 kW		
2.3 kW domestic socket (single-phase 10 A) (20-100%)	10 h 50 min		
7.4kW wallbox (32A single-phase) (20-100%)	4h		
30 kW DC rapid charger (20-80%)	-	45 min**	45 min**
POWER SAVING FUNCTIONS			
ECO mode	Yes		
CHASSIS - STEERING AND AXLES			
Front axle type	Pseudo-MacPherson with wishbone arm		
Rear axle type	H-type torsion beam with programmed deflection suspension and spiral springs		
Type of steering	Power assisted steering		
Turning circle, kerb-to-kerb (m) (official measurement)	9.63		
Steering wheel turns (lock to lock)	4.8		
BRAKING			
Front: ventilated disc Ø (mm)	238		
Rear: drum/solid disc Ø (mm)	170		
Brake servo size (")	8		
WHEELS AND TYRES			
Tyre sizes (that causes variations in the level of CO ₂ inside a powertrain model)	165/70 R14	165/65 R15	165/70 R14
Wheels (tyres + rims) all versions	14" wheel rims	15" wheel rims	14" wheel rims
WEIGHT (KG)			
Max kerb weight	976	984	984
Kerb weight on front axle/on rear axle	531/445	539/455	539/455
Payload	331/381		370
Gross vehicle weight (GVW)	1,315		

* WLTP (Worldwide Harmonised Light Vehicle Test Procedures): this new protocol provides results much closer to those found in daily use compared with the NEDC protocol. Range and fuel consumption are approved according to a standard, regulatory method. It is identical for all manufacturers and allows vehicles to be compared. ** Optional.

[CONFIGURE AND ORDER](#)

[MENU](#) 

06. EQUIPMENT & OPTIONS

	EXPRESSION	EXTREME	CARGO 65
EXTERNAL APPEARANCE			
Automatic activation of LED daytime running lights	•	•	•
Rear lights with Y-shaped Dacia brand light	•	•	•
Exterior door handles	Body coloured	Body coloured	Body coloured
Door mirrors	Black grain effect	Copper Brown	Black grain effect
14" steel wheels	Cians wheel cap	-	Cians wheel cap
15" steel wheels	Resia wheel trim for 65 hp version	Danube wheel cap	-
Side decal on door	•	•	•
Side decal on quarter panel with Spring wording	-	•	•
Dacia lettering on boot lid	White	Copper Brown	White
INTERIOR APPEARANCE			
Side air vent surrounds	Steel grey	Copper Brown	Steel grey
Interior door handles	Steel grey	Steel grey	Steel grey
Seat coverings	Two-tone fabric with Dacia logo embossing	Plastic-coated textile / fabric with Dacia embossing and copper brown top-stitching	Two-tone fabric with Dacia logo embossing
Air conditioning control button surrounds	Steel grey	Steel grey	Steel grey
ACTIVE AND PASSIVE SAFETY			
Traffic sign recognition with speed alert	•	•	•
Emergency call (E-call)	•	•	•
Anti-locking braking system (ABS) + Emergency Brake Assist (EBA) with emergency stop signal	•	•	•
Automatic emergency braking with pedestrian/cyclist/motobike detection	•	•	•
Lane change warning	•	•	•
Lane keeping assist	•	•	•
Driver fatigue detection system	•	•	•
My Safety button to easily manage driver assistance systems ⁽¹⁾	•	•	•
Front / rear "Rescue Code [®] " QR Code	•	•	•
Electronic Stability Control (ESC) with Hill Start Assist (HSA)	•	•	•
Driver's front airbag	•	•	•
Passenger's front airbag (can be deactivated)	•	•	•
Shoulder and curtain side airbags	•	•	•
Front and rear seat belts with pyrotechnic pretensioner	•	•	•
Tyre pressure detection	•	•	•
Tyre inflation kit	•	•	•
Isofix attachment system for child seats in the rear seats	•	•	•
Manual parking brake	•	•	•
DRIVING AND CONTROL INSTRUMENTS			
Power assisted steering	•	•	•
YouClip 3 fixation points for compatible accessory attachment ⁽¹⁾	•	•	•
Configurable 7" digital instrument panel and 13-function on-board computer	•	•	•
Visual and audible front and rear seat belt warning	•	•	•
Eco Mode	•	•	•
Cruise control and speed limiter	•	•	•
Rear parking sensors	•	•	•
Front parking sensors	-	•	•
Rear-view camera	-	•	•

•: available as standard; ◊: available as an option; -: not available. (1) For configurable driving aids.

VISIBILITY

Rear window demisting	•	•	•
Electric door mirrors	-	•	•

COMFORT

Manual heating and air conditioning system	•	•	•
Dedicated regenerative braking mode (mode B on e-shifter gear selector)	•	•	•
Remote central locking and with key	•	•	•
Electric front windows	•	•	•
Electric rear windows	-	•	•
Height-adjustable steering wheel	•	•	•
Front reading spotlight	•	•	•
Front 12V socket	•	•	•
1/1 folding rear bench seat	•	•	•

MULTIMEDIA & AUDIO

New Media Control: DAB digital radio, 1 USB-C socket, 2 speakers, Bluetooth® connection with side controls on the steering wheel, new application for Dacia Media Control smartphone app	•	-	-
New Media Nav Live: multimedia system with 10.1" touchscreen, connected navigation with automatic map updates, real-time traffic info and danger zones for 8 years* (including mobile license and data), DAB digital radio, smartphone mirroring via USB cable or wireless via Wi-Fi, 2 USB-C sockets, Bluetooth® connection, steering wheel satellite controls, 2 speakers, Dacia app store and remote services pack* (see Connected services)	-	•	•

CHARGING

mode 3 type 2 charging cable for Wallbox and public terminals*	•	•	•
DC combination socket (30 kW) for rapid charging (65 hp versions only)	•	•	•

CONNECTED SERVICES*

Remote services pack (via the My Dacia application) included for 8 years: - Find my vehicle (remote geolocation on a map) - My dashboard data (distance travelled, driving range, state of charge, etc.) - Charge scheduling - Remote action: temperature setting, charging, etc.	-	•	•
FOTA (Firmware Over The Air): for installing software patches directly to the car, without the need for dealer intervention (up to 5 years)	-	•	•

-: not available; •: available as standard; ◊: available as an option. * Depending on the country. Android Auto™ is a trademark of Google Inc. Apple CarPlay™ is a trademark of Apple Inc. (1) For configurable driving aids. (2) For 65 hp version. (3) Connected insurance services available depending on the insurance companies: please contact your insurer.

CONFIGURE AND ORDER

MENU 

07. PRICING & OPTIONS

	CO ₂ G/KM WLTP	FUEL TYPE	BHP	BENEFIT IN KIND	VED YEAR 1	BASIC PRICE	VAT 20%	TOTAL RETAIL PRICE	ON THE ROAD PRICE*	MRRP AFTER PIVG**
EXPRESSION										
Electric 45	0	Electric	45	2%	£0	£11,866.67	£2,373.33	£14,240	£14,995	
Electric 65	0	Electric	65	2%	£0	£12,700.00	£2,540.00	£15,240	£15,995	
EXTREME										
Electric 65	0	Electric	65	2%	£0	£13,533.33	£2,706.67	£16,240	£16,995	
CARGO										
Electric 65	0	Electric	65	2%	£0	£14,995.00	£2,999.00	£17,994	£18,749	£16,249

* "On the Road" price includes delivery to the dealer premises, number plates, 12 months government road fund license (depending on CO₂ emissions) and First Registration Fee at £55. **Plug in Van Grant (£2,500).

OPTIONS	EXPRESSION	EXTREME	CARGO	BASIC PRICE	VAT 20%	TOTAL RETAIL PRICE
Metallic & Special Paint	○	○	-	£541.67	£108.33	£650

07. DIMENSIONS

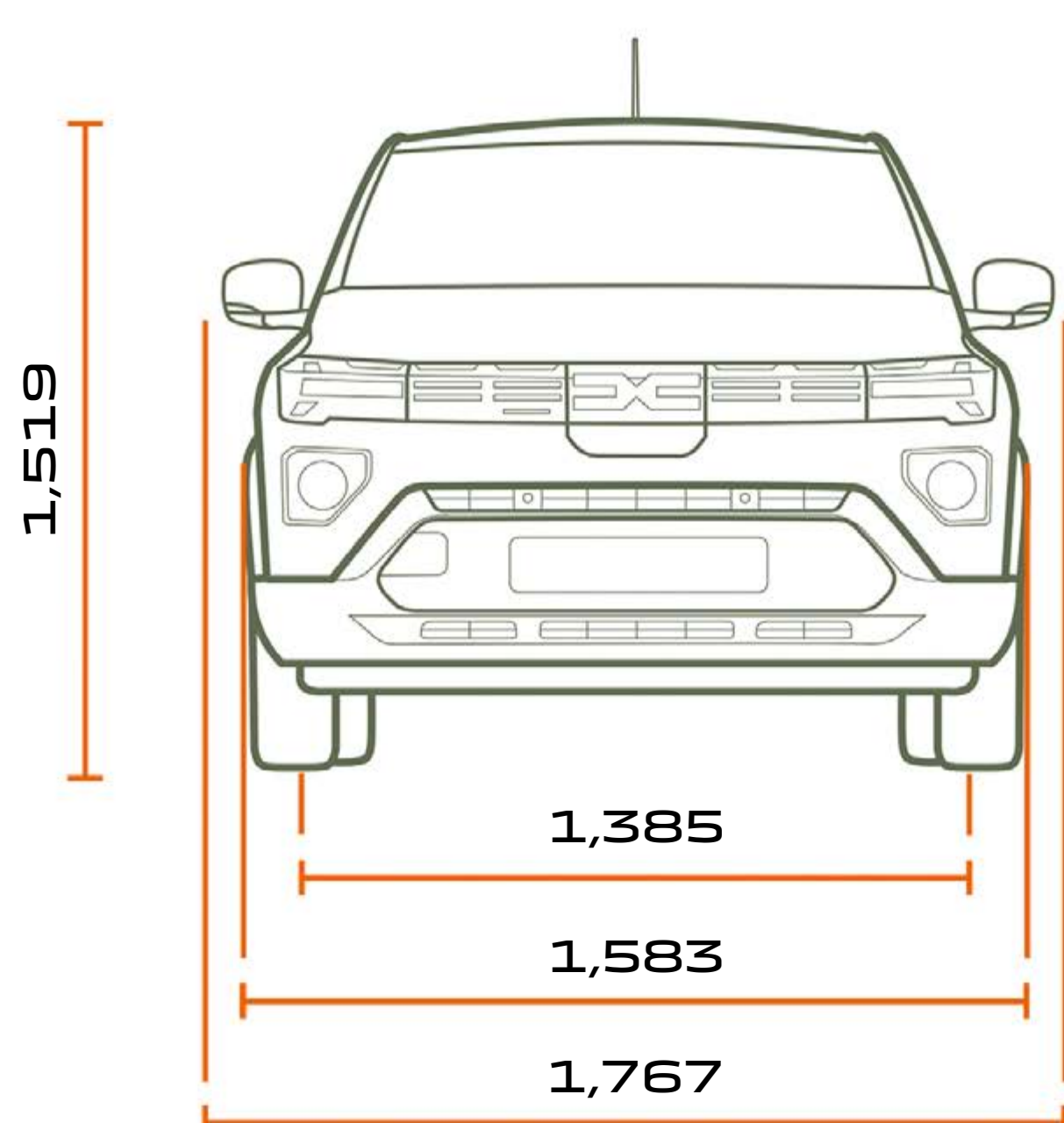

FRONT VIEW

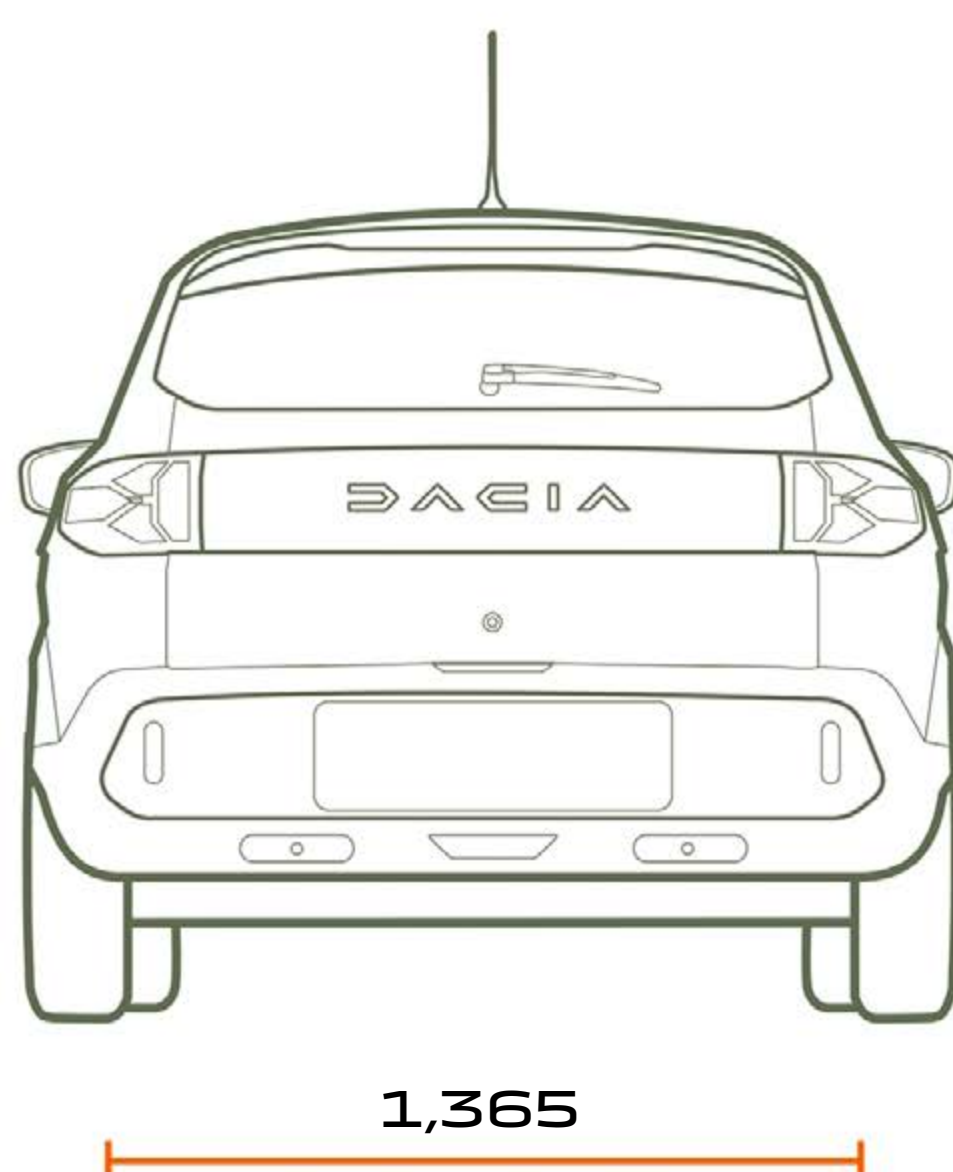

REAR VIEW

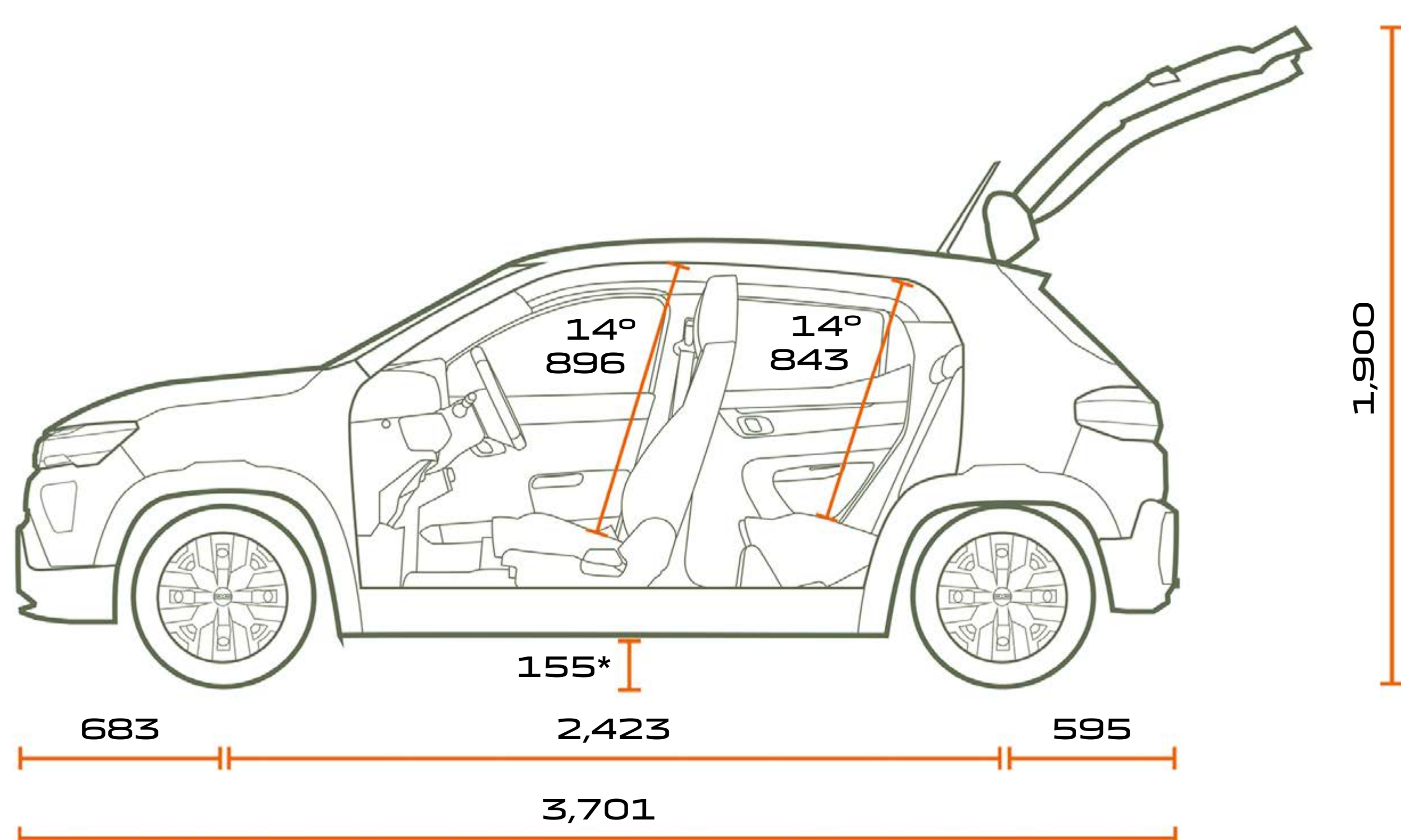

SIDE-FACE VIEW

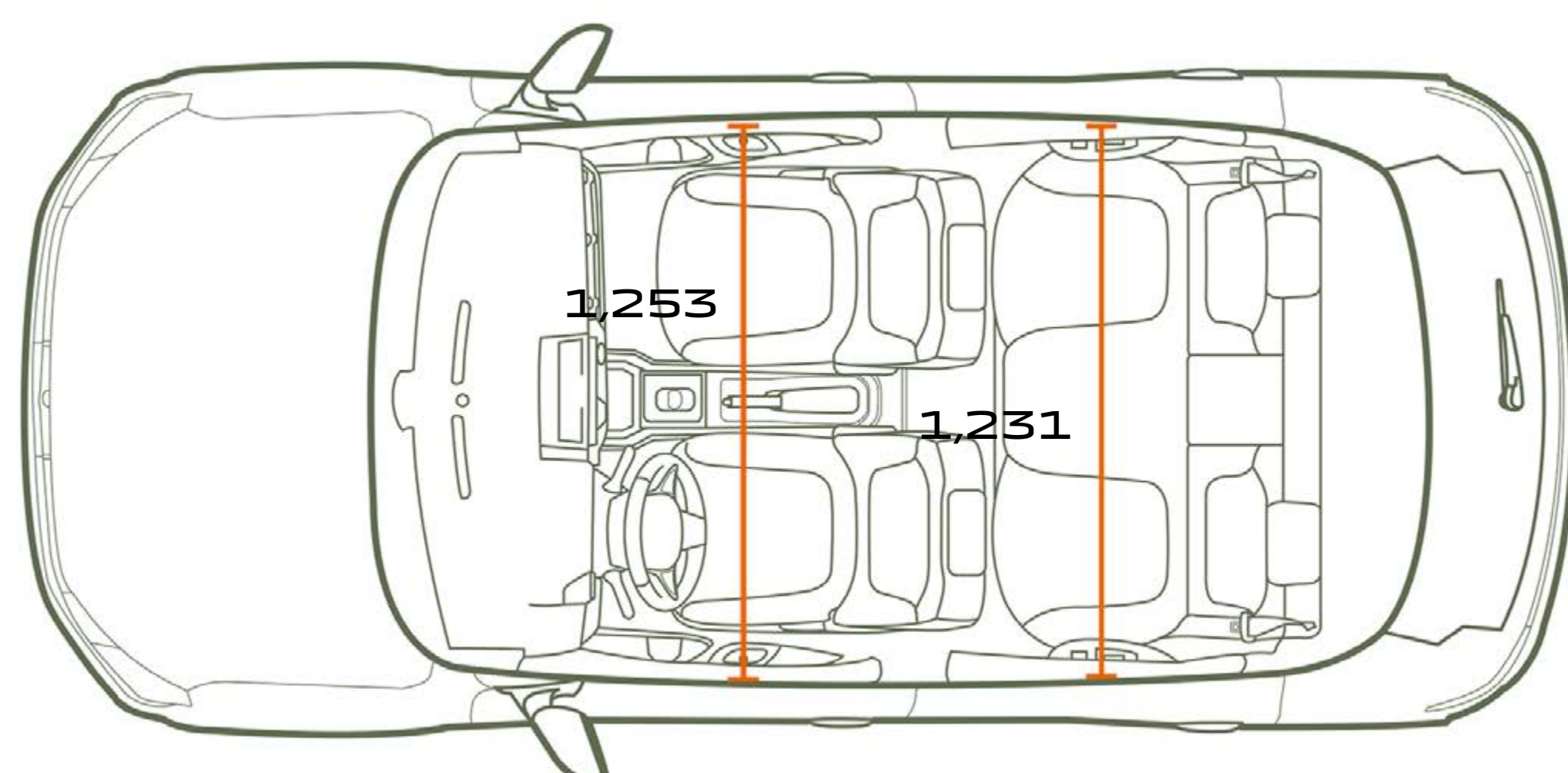

TOP VIEW

SPECIFIC VERSIONS

Minimum boot volume (ISO 3832 standard) (in dm ³ VDA standard / litres)	288/308
Maximum boot volume behind row 1 seat, with row 2 seat folded down (ISO 3832 standard) (in dm ³ VDA standard / litres)	975/1,004

CARGO VERSION

Boot volume (ISO 3832 standard) (in dm ³ VDA standard / litres)	936/1,085
Loading length (in mm)	1,177

Dimensions in mm. *With 15" wheels. Maximum Payload 370kg.

CONFIGURE AND ORDER

MENU ^

ENJOY THE RIDE WITH DACIA ZEN



DACIA ZEN ENABLES OWNERS TO ENJOY UP TO SEVEN YEARS OF WARRANTY

- Brand new Dacia Zen warranty offers Dacia owners up to seven years of cover
- It's applicable to all Dacia models under six years old which have covered less than 75,000 miles
- Warranty is complimentary with every service completed at an official Dacia retailer
- Dacia Zen is available to owners of qualifying vehicles even if their Dacia has been previously serviced outside of the official Dacia retail network

WHO BETTER TO LOOK AFTER YOUR DACIA, THAN DACIA?

Are you the proud owner of a new or used Dacia? If your vehicle is less than 6 years old and has covered less than 75,000 miles you can get up to 7 years warranty with Dacia*

It's simple. Get your Dacia serviced by one of our expert retailers after your standard 3-year warranty expires and enjoy a Dacia ZEN warranty for a year or 18,000 miles (whichever comes sooner).

Enjoy the ride with Dacia ZEN.



Your Dacia is less than 6-years old and has done less than 75,000 miles



Have your next manufacturer service carried out in our retailer network



Get an additional 1-year of warranty*

*Warranty activated following service at participating Dacia Dealers. Valid for 1 year or 18,000 miles (whichever comes first). Vehicles over 6 years old or 75,000 miles not eligible. Full T&Cs apply.

[BOOK A SERVICE](#)

WE'VE GOT YOU COVERED

You might think our shockingly affordable prices mean our cars aren't made to last. Actually, the Dacia range is one tough cookie. To prove it, you get a 3-year* warranty (or 60,000 miles, if you reach that first). This means we will replace any part which has been deemed by a Dacia approved dealer to be defective due to a manufacturing fault, free of charge. To keep the good times rolling, you can extend your warranty up to 7 years for a great price. We also give you a 2-year paintwork and 6-year anti-corrosion warranty, so you can kick back knowing that your Dacia will stay looking good-as-new for years to come.

ROADSIDE ASSISTANCE

Although our cars are built for plain sailing, you can rely on us if you have a breakdown – 24/7 365, wherever you are in the UK or Northern Ireland. This offer also stands for the first 3 years/60,000 miles^Δ after you buy your new Dacia.

DACIA CAR INSURANCE 1

Dacia Insurance has been specifically created to provide superb protection for you and your car. Unlike most other UK insurers, in the event of an accident, your Dacia will be repaired at a Dacia Approved Bodyshop using only Dacia approved parts and approved repair methods. This maintains your Dacia's safety rating, protects its resale value and helps to maintain its Dacia warranty[^]. Dacia Insurance also offers a courtesy car for the duration of a repair at a Dacia Approved Bodyshop.

Dacia car insurance: 0330 102 7795 www.daciacarinsurance.co.uk

Lines are open Mon - Thurs 8.30am - 7pm, Fri 9am - 6pm, Sat 9am - 5pm

SERVICING

Dacia Service Plans are the ultimate hassle free way to take care of your vehicle. Depending on the Service plan you purchase (grid below) your servicing needs are covered and you benefit from;

- Inflation Proof Servicing – You know exactly what you'll pay and there are no hidden costs
- Peace of Mind – No matter where life takes you, we'll be there in over 5000 workshops across Europe
- Dacia Expertise & Quality – Our highly trained technicians know your Dacia inside out

The Dacia Service Plan contains Dacia services in-line with the manufacturer's service schedule, plus comes with a complimentary vehicle health check to ensure your Dacia is in the best condition possible.

SERVICE PLAN [^]	Monthly payments
3 years / 48,000 miles Service Plan	£11.99 per month
3 years / 54,000 miles Service Plan	£13.99 per month
4 years / 48,000 miles Service Plan + 1 MOT	£14.99 per month
4 years / 60,000 miles Service Plan + 1 MOT	£16.99 per month

EXTENDED WARRANTY	Total Retail Price
1 years / 100,000 miles [†]	£520
2 years / 100,000 miles [†]	£560
3 years / 100,000 miles [†]	£685
4 years / 100,000 miles [†]	£885

Dacia Extended warranty ends when you reach the age or mileage limit (whichever comes first). All prices including VAT.

*Dacia warranty ends when you reach the age or mileage limit (whichever comes first), from date of registration. Subject to status, terms and conditions apply. For full Dacia Extended Warranty Terms and Conditions visit www.dacia.co.uk/warranty-and-assistance/warranty

^ΔRoadside assistance for the first 3 year / 60,000 miles, which ever is reached first, from date of registration. For full Terms and Conditions visit www.dacia.co.uk/warranty-and-assistance/assistance

[†] Dacia Extended warranties are available to purchase from first date of registration up to end of manufacturer warranty. For full Dacia Extended Warranty Terms and Conditions visit www.dacia.co.uk/warranty-and-assistance/warranty

[^] The Service plan offer is available for eligible retail vehicles only and valid at participating dealers only. Vehicles must be ordered between 17 December 2024 to 31 March 2025 and registered by 30 June 2025. The Dacia Service plan covers the manufacturer's minimum maintenance requirements and servicing intervals within +/- 1 month or 1,000 miles of the service interval and can only be carried out at a Dacia Approved outlet. Service plans do not cover wear and tear items such as (but not limited to) tyres, wiper blades or brakes. For Service plan full Terms & Conditions visit www.dacia.co.uk/services-and-finance/service-plan. Cannot be part exchanged, refunded or transferred.

¹ Dacia Insurance is arranged and administered by Verex Insurance Services Ltd, which is registered in England and Wales No. 05686831 at Batchworth House, Church Street, Rickmansworth, Herts, WD3 1JE and is authorised and regulated by the Financial Conduct Authority, No. 487185. Verex Insurance Services Ltd arranges policies from a panel of insurers, details are available on request.

^ΔIf your insurer uses non-approved parts which subsequently fail, they may not be covered under your manufacturer's warranty.

DACIA



Every precaution has been taken to ensure that the contents of this brochure were accurate and up-to-date at the time of publication. This document was created using pre-production models and prototypes. In line with its policy of continuous product improvement, Dacia reserves the right to modify the specifications, vehicles and accessories described and featured at any time. Any such modifications are communicated to Dacia dealers as quickly as possible. Depending on the country of sale, versions may differ and some equipment may be unavailable (standard, optional or accessory). Please consult your Dacia brand representative for the latest information. For reasons to do with the medium, the colours featured in this document may differ slightly from those of the actual paintwork or interior trim. All rights reserved. Reproduction in any format and by any means of all or part of this brochure is prohibited without prior written authorisation from Dacia.

Dacia recommends  Castrol

PUBLICIS – PHOTO CREDITS: BAM (BEN & MARTIN), © RENAULT MARKETING 3D-COMMERCE – DECEMBER 2024



**CONFIGURE
AND ORDER**

**BOOK
A TEST DRIVE**

**FIND YOUR
NEAREST CENTRE**

MENU 